

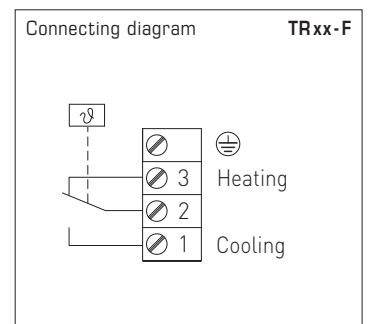

Mechanical temperature controller THERMASREG® TR xx - F with remote sensor and switching output (one-step), working as capillary thermostat / capillary controller without external voltage. This capillary controller is used for monitoring and to control temperatures of non-aggressive liquid or gaseous media in heating, ventilation and air conditioning technology as well as in mechanical and apparatus engineering, for installation in immersion sleeves or air conditioning ducts.

TECHNICAL DATA	
Switching capacity: (Contact load)	24...250 V AC +10%, 16 A, cos φ = 1.0 24...250 V AC +10%, 1.5 A, cos φ = 0.6 at 24 V AC min. 150 mA
Contact:	dust-proof switch block unit as potential-free single-pole changeover contact
Housing:	plastic, UV-resistant, material polyamide, 30% glass-globe reinforced, colour traffic white (similar to RAL 9016)
Housing dimensions:	108 x 70 x 73.5 mm (Thor 2)
Cable gland:	M20 x 1.5; including strain relief
Housing temperature:	-10...+65 °C
Design principle:	torsion meter with liquid filling
Sensor:	copper tube, length of capillary = 1 m with PVC protective hose, Ø 6.8 mm
Tolerance:	T _{min} ± 3 K; T _{max} ± 3 K
Inserted length:	immersion sleeves EL = 150 mm (accessories see table)
Routing:	bending radius > 35mm admissible vibration load ≤ ½g admissible tensile load < 100N
Electrical connection:	0.14 - 2.5 mm ² via terminal screws
Protection class:	I (according to EN 60 730)
Protection type:	IP 65 (according to EN 60 529)
Standards:	CE conformity according to EMC directive 2014 / 30 / EU, low-voltage directive 2014 / 35 / EU

FUNCTION
Heating: wire contacts 2 - 3
Cooling: wire contacts 2 - 1

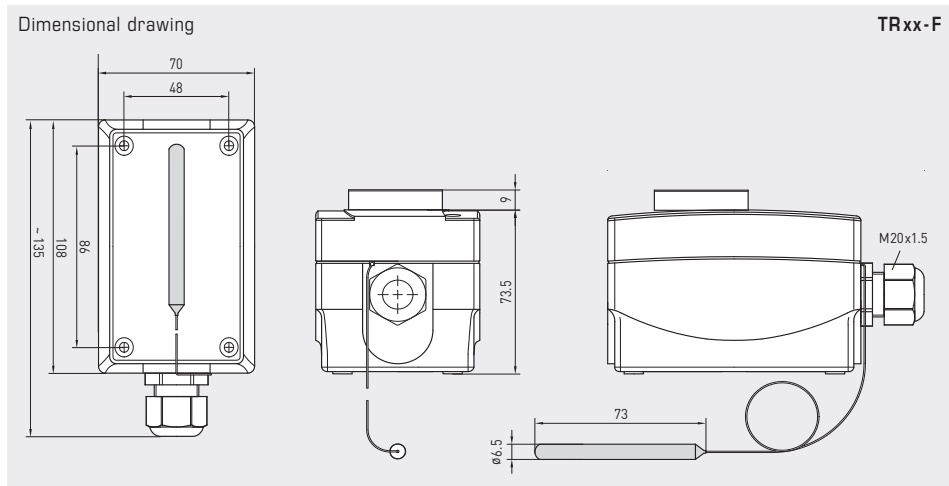

THERMASREG® TR xx - F Temperature controllers, one-step					
Type / WG01	Temperature Range	Thermal Operating Difference (fixed) approx.	Max. Capillary Temperature	Item No.	Price
				TR (External setting)	
TRxx-F					
TR-1-F	-35... +35 °C	3 K (± 1 K)	+60 °C	1102-1056-1110-100	88,05 €
TR-060-F	0... +60 °C	3 K (± 1 K)	+75 °C	1102-1050-1110-300	88,05 €
TR-090-F	0... +90 °C	3 K (± 1 K)	+120 °C	1102-1050-1110-400	88,05 €
TR-0120-F	0...+120 °C	5 K (± 1 K)	+135 °C	1102-1050-1110-500	88,05 €
TR-50140-F	+50...+140 °C	5 K (± 1 K)	+150 °C	1102-1050-1110-600	88,05 €
Extra charge:	U = Internal setting (TW), e.g. TR-090-F-U				10,98 €
ACCESSORIES					
THR-MS-08/150	Brass immersion sleeve, EL = 150 mm, Ø 8 x 0.5 mm			7100-0011-3404-000	17,16 €
THR-VA-09/150	Stainless steel immersion sleeve V2A (1.4301), EL = 150 mm, Ø 9 x 1.0 mm			7100-0012-3032-000	45,23 €
For further information, see the last chapter!					