



Mechanical temperature controller / wet room temperature controller **THERMASREG® TR 22** with switching output (one-step) and copper capillary, working without external voltage. It is used for monitoring and controlling temperatures in heat generation plants, in heating, ventilation and air conditioning systems, for ventilation, cooling and climate control in halls, cold storage rooms, greenhouses, nurseries, stables, breeding rooms, as industrial room thermostat or surface-mounted thermostat in industrial applications as well as in wet room and outdoor areas.

TR 22
(one-step)
TR

TECHNICAL DATA

Switching capacity: (Contact load)	24...250V AC +10%, 16 A, cos φ = 1.0 24...250V AC +10%, 1.5 A, cos φ = 0.6 at 24V AC min. 150 mA
Contact:	dust-proof switch block unit as potential-free single-pole changeover contact
Housing:	plastic, UV-resistant, material polyamide, 30% glass-globe reinforced, colour traffic white (similar to RAL 9016)
Housing dimensions:	108 x 70 x 73.5 mm (Thor 2)
Cable gland:	M20 x 1.5; including strain relief
Housing temperature:	-35...+65 °C
Design principle:	torsion meter with liquid filling
Capillary:	copper
Tolerance:	T _{min} ± 3K; T _{max} ± 3K
Routing:	admissible vibration load ≤ ½g
Electrical connection:	0.14 - 2.5 mm² via terminal screws
Protection class:	I (according to EN 60 730)
Protection type:	IP 65 (according to EN 60 529)
Standards:	CE conformity according to EMC directive 2014 / 30 / EU, low-voltage directive 2014 / 35 / EU

FUNCTION

Heating: The preset setpoint (scale value) is equivalent to the switch-off value of the heating. The switch-on value is lower by the amount of operating difference. Contact 2 - 3 breaks when temperature rises to the preset value.

Cooling: The preset setpoint (scale value) is equivalent to the switch-on value of the cooling. The switch-off value is lower by the amount of operating difference. Contact 1 - 2 closes when temperature rises to the preset value.



TR 22 U
(one-step)
TW



Dimensional drawing

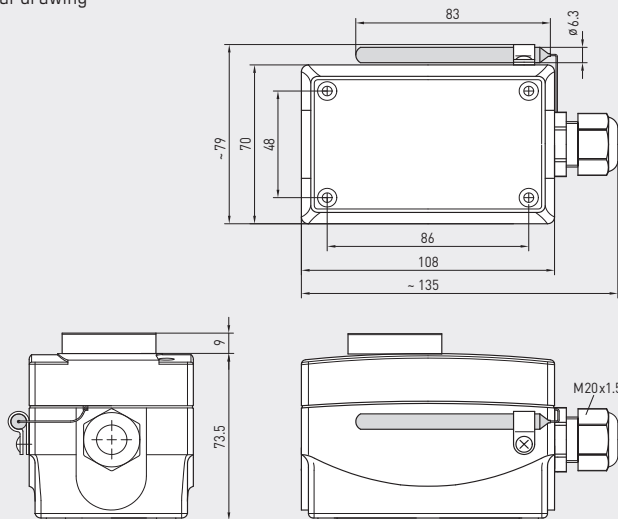

TR 22

Connecting diagram

TR 22

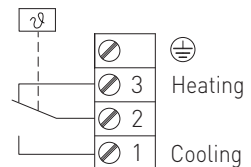

THERMASREG® TR 22 Temperature controllers, one-step

Type / WG01	Temperature Range	Thermal Operating Difference (fixed) approx.	Max. Capillary Temperature	Item No.	Price
TR 22				TR (External setting)	
TR-22	-35...+35 °C	3K (± 1K)	+60 °C	1102-1050-1100-100	86,88 €
TR 22 U				TW (Internal setting)	
TR-22 U	-35...+35 °C	3K (± 1K)	+60 °C	1102-1050-2100-100	85,48 €