

**Temperature controllers, two-step,
with switching output**

Mechanical temperature controller/wet room temperature controller **THERMASREG® TR 04040** with two independently switching outputs, which are separately adjustable (e.g. for switching between day and night time) and stainless steel capillary (spiral coil sensor), working without external voltage. It is used for monitoring and controlling temperatures in heat generation plants, in heating, ventilation and air conditioning systems, for ventilation, cooling and climate control in halls, cold storage rooms, greenhouses, nurseries, stables, breeding rooms, as industrial room thermostat or surface-mounted thermostat in industrial applications as well as in wet room and outdoor areas.

TECHNICAL DATA

Switching capacity:	24...250V AC +10%, 16A, cos φ = 1.0 (Contact load) 24...250V AC +10%, 1.5A, cos φ = 0.6 at 24V AC min. 150mA
Contact:	dust-proof switch block unit as potential-free single-pole changeover contact (two changeover contacts, separately adjustable)
Housing:	plastic, UV-resistant, material polyamide, 30% glass-globe reinforced, colour traffic white (similar to RAL 9016)
Housing dimensions:	108 x 70 x 73.5 mm (Thor 2)
Cable gland:	2x M20 x 1.5; including strain relief
Housing temperature:	-10...+65 °C
Capillary:	stainless steel V2A (1.4303)
Tolerance:	T _{min} ± 3K; T _{max} ± 3K; at +20 °C ± 1K
Electrical connection:	0.14 - 2.5 mm ² via terminal screws
Routing:	admissible vibration load ≤ ½g
Protection class:	I (according to EN 60 730)
Protection type:	IP 65 (according to EN 60 529)
Standards:	CE conformity according to EMC directive 2014 / 30 / EU, low-voltage directive 2014 / 35 / EU

FUNCTION

Heating: Contacts 2-3 and 5-6 break when temperature rises to the preset value.
Cooling: Contacts 2-1 and 5-4 break when temperature drops to the preset value.

Dimensional drawing **TR 04040**

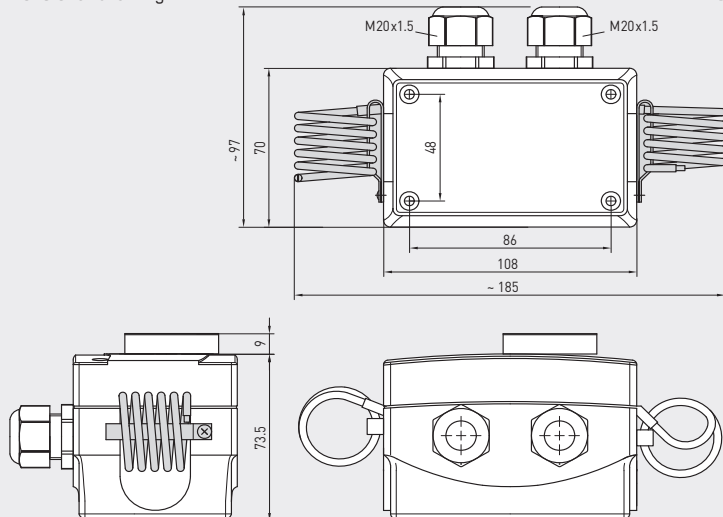

TR 04040



TR 04040 U



Connecting diagram **TR 04040**

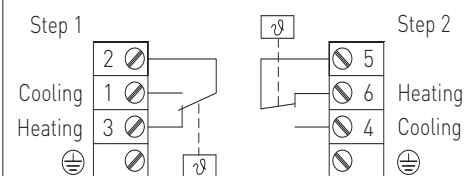

THERMASREG® TR 04040 Temperature controllers, two-step

Type / WG01	Temperature Range (adjustable)		Thermal Operating Difference (fixed) approx.		Max. Capillary Temperature	Item No.	Price
	1.	2.	1.	2.			
TR 04040						TR + TW (External/Internal setting)	
TR-04040	0...+40 °C	0...+40 °C	2K	2K	+65 °C	1102-1050-1200-200	127,81 €
TR 04040 U						TW + TW (Internal setting)	
TR-04040 U	0...+40 °C	0...+40 °C	2K	2K	+65 °C	1102-1050-2200-200	127,81 €