

**Temperature controllers, one-step,
with switching output**

Mechanical temperature controllers/wet room temperature controllers **THERMASREG® TR 040 / TR 060** with switching output (one-step) and stainless steel capillary (spiral coil sensor), working without external voltage. They are used for monitoring and controlling temperatures in heat generation plants, in heating, ventilation and air conditioning systems, for ventilation, cooling and climate control in halls, cold storage rooms, greenhouses, nurseries, stables, breeding rooms, as industrial room thermostat or surface-mounted thermostat in industrial applications as well as in wet room and outdoor areas.

TECHNICAL DATA

Switching capacity: (Contact load)	24...250V AC +10%, 16A, cos φ = 1.0 24...250V AC +10%, 1.5A, cos φ = 0.6 at 24V AC min. 150mA
Contact:	dust-proof switch block unit as potential-free, single-pole or two-pole changeover contact
Housing:	plastic, UV-resistant, material polyamide, 30% glass-globe reinforced, colour traffic white (similar to RAL 9016)
Housing dimensions:	108 x 70 x 73.5 mm (Thor 2)
Cable gland:	M20 x 1.5; including strain relief
Housing temperature:	-35...+65 °C
Capillary:	stainless steel V2A (1.4303)
Tolerance:	T _{min} ± 3K; T _{max} ± 3K; at +20°C ± 1K
Electrical connection:	0.14 - 2.5 mm ² via terminal screws
Routing:	admissible vibration load ≤ ½g
Protection class:	I (according to EN 60 730)
Protection type:	IP 65 (according to EN 60 529)
Standards:	CE conformity, EMC directive 2014 / 30 / EU, low-voltage directive 2014 / 35 / EU

FUNCTION

- Heating:** The preset setpoint (scale value) is equivalent to the switch-off value of the heating. The switch-on value is lower by the amount of operating difference. Contact 2-3 breaks when temperature rises to the preset value.
- Cooling:** The preset setpoint (scale value) is equivalent to the switch-on value of the cooling. The switch-off value is lower by the amount of operating difference. Contact 1-2 closes when temperature rises to the preset value.

Dimensional drawing

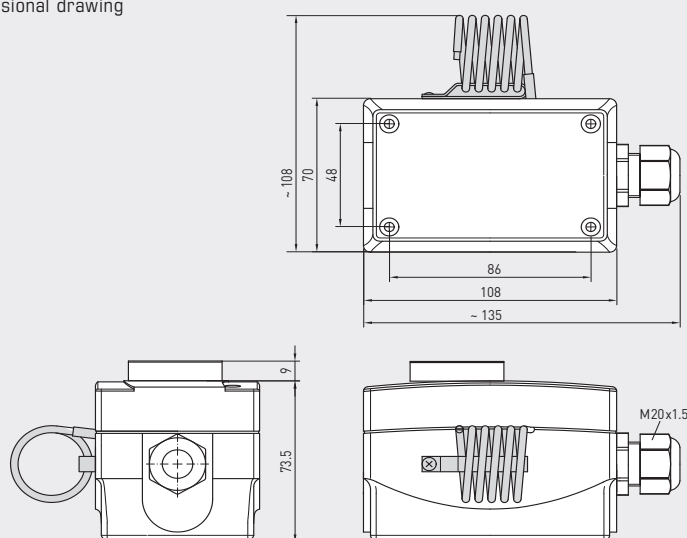

TR 040
TR 060

TR 040
TR 060
(one-step)
TR



TR 040 U
TR 060 U
(one-step)
TW



Connecting diagram

TR 040
TR 060

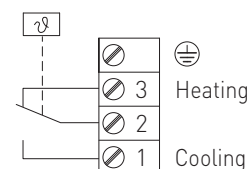

THERMASREG® TR 040 / TR 060 Temperature controllers, one-step

Type / WG01	Temperature Range	Thermal Operating Difference (fixed) approx.	Max. Capillary Temperature	Item No.	Price
TR 040 / 060					TR (External setting)
TR-040	0...+40 °C	2K	+65 °C	1102-1050-1100-200	86,88 €
TR-060	0...+60 °C	2K	+75 °C	1102-1050-1100-300	86,88 €
TR 040 U / 060 U					TW (Internal setting)
TR-040 U	0...+40 °C	2K	+65 °C	1102-1050-2100-200	85,48 €
TR-060 U	0...+60 °C	2K	+75 °C	1102-1050-2100-300	85,48 €