

**Immersion / screw-in / duct temperature sensors
with passive output**

Patented quality product (Immersion sensor patent no. DE 10 2012 017 500.0)

THERMASGARD® TF 43 is a resistance thermometer with a passive output, housing made from impact-resistant plastic with snap-on lid, and straight protective tube.

THERMASGARD® TF 65 is a resistance thermometer with a passive output, housing made from impact-resistant plastic with quick-locking screws, and straight protective tube.

These immersion / screw-in / duct temperature sensors are electric contact thermometers for temperature measurement in liquids and gases, which are installed for example in piping systems and vessels. For aggressive media, stainless steel immersion sleeves must be used.

Applications of these temperature sensors in piping systems, in heating technology, in storage tanks, in district heating compact stations, in hot and cold-water systems, in oil and lubricant circulation systems, in mechanical, apparatus and plant engineering as well as in the entire industrial sector.

TECHNICAL DATA

Measuring range:	-30...+150 °C (T _{max} NTC = +150 °C, T _{max} LM235Z = +125 °C)
Sensors / output:	see table, passive (Perfect Sensor Protection) (optional also with two sensors)
Connection type:	2-wire connection (4-wire connection on PT100/PT1000A, optional on other sensors)
Testing current:	< 0.6 mA (Pt1000) < 1.0 mA (Pt100) < 0.3 mA (Ni1000, Ni1000 TK5000) < 2.0 mW (NTC xx) 400 µA...5 mA (LM235Z)
Insulating resistance:	≥ 100 MΩ, at +20 °C (500 V DC)
Ambient temperature:	-20...+100 °C
Housing:	plastic, UV-resistant, material polyamide, 30% glass-globe reinforced, colour traffic white (similar to RAL 9016) TF 43 with snap-on lid TF 65 with quick-locking screws (slotted / Phillips head combination)
Housing dimensions:	72 x 64 x 37.8 mm (Tyr 1 / Tyr 01)
Cable connection:	cable gland , plastic (M 16 x 1.5; with strain relief, exchangeable, max. inner diameter 10.4 mm) or M12 connector according to DIN EN 61076-2-101 (optional on request)
Electrical connection:	0.14 - 1.5 mm ² , via terminal screws
Protective tube:	stainless steel, V4A (1.4571), Ø = 6 mm, inserted length (EL) = 50 - 400 mm (see table)
Permissible humidity:	< 95% RH, non-precipitating air
Protection class:	III (according to EN 60 730)
Protection type:	TF 43 IP 54 (according to EN 60 529)* Housing tested, TÜV SÜD, Report No. 713160960A (Tyr 01) TF 65 IP 67 (according to EN 60 529)* Housing tested, TÜV SÜD, Report No. 713139052 (Tyr 1) * Housing in the built-in state

ACCESSORIES

MF-15-K	Mounting flange , plastic, 56.8 x 84.3 mm, Ø = 15.2 mm tube gland, T _{max} = +100 °C
TH08-MS-G / xx	Immersion sleeve, polished brass , Ø = 8 mm, T _{max} = +150 °C, p _{max} = 10 bar
TH08-VA / xx	Immersion sleeve, stainless steel, V4A (1.4571), Ø = 8 mm, T _{max} = +600 °C, p _{max} = 40 bar
TH08-VA / xx / 90	Immersion sleeve, stainless steel, V4A (1.4571), with neck tube (90 mm), Ø = 8 mm, T _{max} = +600 °C, p _{max} = 40 bar

High-performance encapsulation against
vibration, mechanical stress and humidity

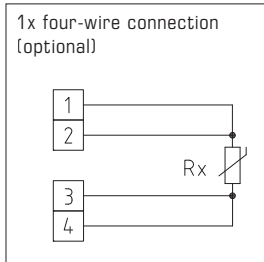
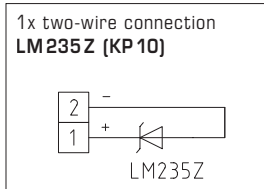
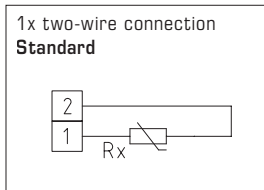



S+S REGELTECHNIK

THERMASGARD® TF 43
THERMASGARD® TF 65

Immersion / screw-in / duct temperature sensors
with passive output

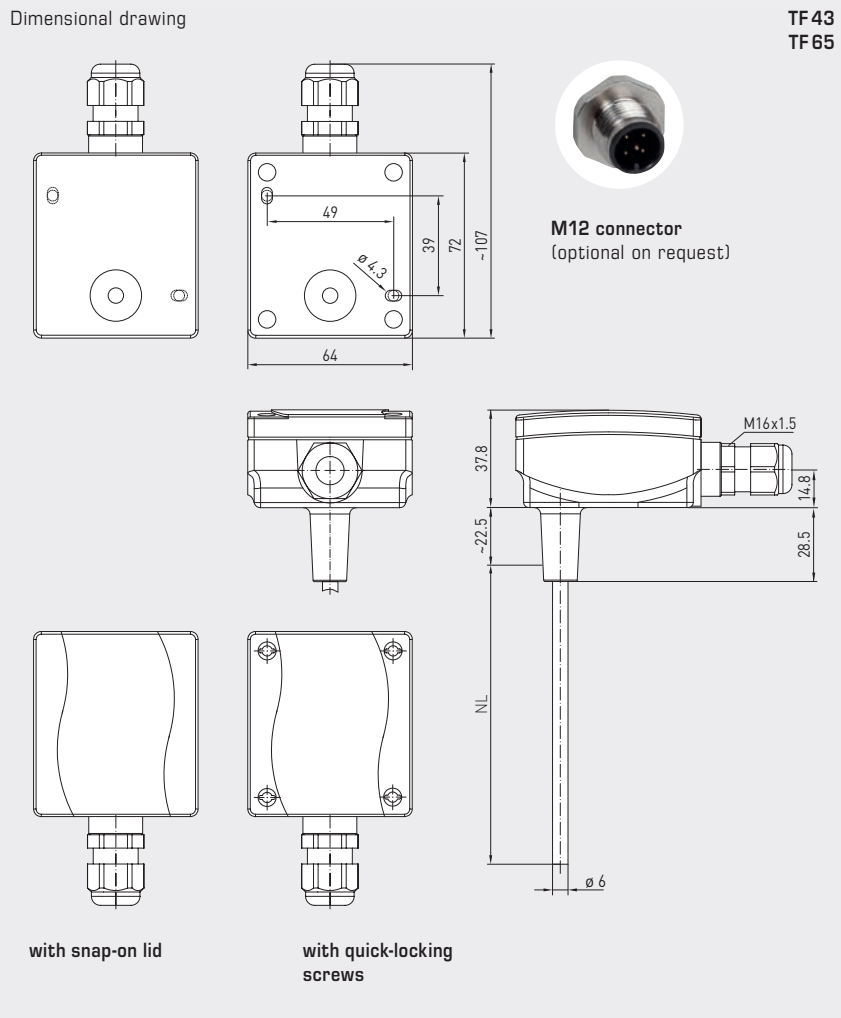

TF 43
with snap-on lid
(IP54)



TF 65
with quick-locking screws
(IP67)



PATENTED



TFxx
Basic device
with accessories

Immersion / screw-in / duct temperature sensors
with passive output

THERMASGARD® TF 65 Temperature sensors (Basic device with quick-locking screws), *Premium*

Type / WG03 / EL	Sensor / Output	Item No.	Price
TF65 PT100 xx	Pt100	IP 67	
TF65 Pt100 50mm	Pt100 (according to DIN EN 60 751, class B)	1101-7020-1013-000	41,73 €
TF65 Pt100 100mm	Pt100 (according to DIN EN 60 751, class B)	1101-7020-1023-000	43,42 €
TF65 Pt100 150mm	Pt100 (according to DIN EN 60 751, class B)	1101-7020-1033-000	45,14 €
TF65 Pt100 200mm	Pt100 (according to DIN EN 60 751, class B)	1101-7020-1043-000	45,80 €
TF65 Pt100 250mm	Pt100 (according to DIN EN 60 751, class B)	1101-7020-1053-000	47,88 €
TF65 Pt100 300mm	Pt100 (according to DIN EN 60 751, class B)	1101-7020-1063-000	49,45 €
TF65 Pt100 350mm	Pt100 (according to DIN EN 60 751, class B)	1101-7020-1073-000	50,36 €
TF65 Pt100 400mm	Pt100 (according to DIN EN 60 751, class B)	1101-7020-1083-000	51,56 €
TF65 PT1000 xx	Pt1000	IP 67	
TF65 Pt1000 50mm	Pt1000 (according to DIN EN 60 751, class B)	1101-7020-5011-000	44,61 €
TF65 Pt1000 100mm	Pt1000 (according to DIN EN 60 751, class B)	1101-7020-5021-000	46,32 €
TF65 Pt1000 150mm	Pt1000 (according to DIN EN 60 751, class B)	1101-7020-5031-000	48,01 €
TF65 Pt1000 200mm	Pt1000 (according to DIN EN 60 751, class B)	1101-7020-5041-000	48,66 €
TF65 Pt1000 250mm	Pt1000 (according to DIN EN 60 751, class B)	1101-7020-5051-000	50,77 €
TF65 Pt1000 300mm	Pt1000 (according to DIN EN 60 751, class B)	1101-7020-5061-000	52,32 €
TF65 Pt1000 350mm	Pt1000 (according to DIN EN 60 751, class B)	1101-7020-5071-000	52,98 €
TF65 Pt1000 400mm	Pt1000 (according to DIN EN 60 751, class B)	1101-7020-5081-000	53,90 €
TF65 PT1000A xx	Pt1000A	IP 67	
TF65 Pt1000A 50mm	Pt1000 (according to VDI/VDE 3512, class A-TGA)	1101-7020-6013-000	46,75 €
TF65 Pt1000A 100mm	Pt1000 (according to VDI/VDE 3512, class A-TGA)	1101-7020-6023-000	47,49 €
TF65 Pt1000A 150mm	Pt1000 (according to VDI/VDE 3512, class A-TGA)	1101-7020-6033-000	49,99 €
TF65 Pt1000A 200mm	Pt1000 (according to VDI/VDE 3512, class A-TGA)	1101-7020-6043-000	50,63 €
TF65 Pt1000A 250mm	Pt1000 (according to VDI/VDE 3512, class A-TGA)	1101-7020-6053-000	52,73 €
TF65 Pt1000A 300mm	Pt1000 (according to VDI/VDE 3512, class A-TGA)	1101-7020-6063-000	54,41 €
TF65 Pt1000A 350mm	Pt1000 (according to VDI/VDE 3512, class A-TGA)	1101-7020-6073-000	56,12 €
TF65 Pt1000A 400mm	Pt1000 (according to VDI/VDE 3512, class A-TGA)	1101-7020-6083-000	56,36 €
TF65 Ni1000 xx	Ni 1000	IP 67	
TF65 Ni1000 50mm	Ni1000 (according to DIN EN 43 760, class B, TCR = 6180 ppm / K)	1101-7020-9011-000	43,83 €
TF65 Ni1000 100mm	Ni1000 (according to DIN EN 43 760, class B, TCR = 6180 ppm / K)	1101-7020-9021-000	45,92 €
TF65 Ni1000 150mm	Ni1000 (according to DIN EN 43 760, class B, TCR = 6180 ppm / K)	1101-7020-9031-000	47,62 €
TF65 Ni1000 200mm	Ni1000 (according to DIN EN 43 760, class B, TCR = 6180 ppm / K)	1101-7020-9041-000	48,27 €
TF65 Ni1000 250mm	Ni1000 (according to DIN EN 43 760, class B, TCR = 6180 ppm / K)	1101-7020-9051-000	50,36 €
TF65 Ni1000 300mm	Ni1000 (according to DIN EN 43 760, class B, TCR = 6180 ppm / K)	1101-7020-9061-000	51,92 €
TF65 Ni1000 350mm	Ni1000 (according to DIN EN 43 760, class B, TCR = 6180 ppm / K)	1101-7020-9071-000	52,98 €
TF65 Ni1000 400mm	Ni1000 (according to DIN EN 43 760, class B, TCR = 6180 ppm / K)	1101-7020-9081-000	53,64 €
TF65 NI1000TK xx	Ni1000 TK5000	IP 67	
TF65 NiTK 50mm	Ni1000 TK5000 (TCR = 5000 ppm / K), LG-Ni1000	1101-7021-0011-000	43,83 €
TF65 NiTK 100mm	Ni1000 TK5000 (TCR = 5000 ppm / K), LG-Ni1000	1101-7021-0021-000	45,92 €
TF65 NiTK 150mm	Ni1000 TK5000 (TCR = 5000 ppm / K), LG-Ni1000	1101-7021-0031-000	47,62 €
TF65 NiTK 200mm	Ni1000 TK5000 (TCR = 5000 ppm / K), LG-Ni1000	1101-7021-0041-000	48,27 €
TF65 NiTK 250mm	Ni1000 TK5000 (TCR = 5000 ppm / K), LG-Ni1000	1101-7021-0051-000	50,36 €
TF65 NiTK 300mm	Ni1000 TK5000 (TCR = 5000 ppm / K), LG-Ni1000	1101-7021-0061-000	51,92 €
TF65 NiTK 350mm	Ni1000 TK5000 (TCR = 5000 ppm / K), LG-Ni1000	1101-7021-0071-000	52,98 €
TF65 NiTK 400mm	Ni1000 TK5000 (TCR = 5000 ppm / K), LG-Ni1000	1101-7021-0081-000	48,97 €

Continued on next page...

High-performance encapsulation against
vibration, mechanical stress and humidity



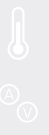

THERMASGARD® TF 65 Temperature sensors (Basic device with quick-locking screws), <i>Premium</i>			
Type/WG03/EL	Sensor/Output	Item No.	Price
TF65 LM235Z xx	LM235Z	IP67	
TF65 LM235Z 50mm	LM235Z (TCR = 10 mV/K; 2.73 V at 0 °C), KP10	1101-7022-1011-000	42,37 €
TF65 LM235Z 100mm	LM235Z (TCR = 10 mV/K; 2.73 V at 0 °C), KP10	1101-7022-1021-000	43,96 €
TF65 LM235Z 150mm	LM235Z (TCR = 10 mV/K; 2.73 V at 0 °C), KP10	1101-7022-1031-000	45,65 €
TF65 LM235Z 200mm	LM235Z (TCR = 10 mV/K; 2.73 V at 0 °C), KP10	1101-7022-1041-000	46,32 €
TF65 LM235Z 250mm	LM235Z (TCR = 10 mV/K; 2.73 V at 0 °C), KP10	1101-7022-1051-000	48,52 €
TF65 LM235Z 300mm	LM235Z (TCR = 10 mV/K; 2.73 V at 0 °C), KP10	1101-7022-1061-000	50,10 €
TF65 LM235Z 350mm	LM235Z (TCR = 10 mV/K; 2.73 V at 0 °C), KP10	1101-7022-1071-000	51,03 €
TF65 LM235Z 400mm	LM235Z (TCR = 10 mV/K; 2.73 V at 0 °C), KP10	1101-7022-1081-000	51,66 €
TF65 NTC 1.8K xx	NTC 1.8K	IP67	
TF65 NTC1,8K 50mm	NTC 1.8K	1101-7021-2011-000	40,05 €
TF65 NTC1,8K 100mm	NTC 1.8K	1101-7021-2021-000	41,73 €
TF65 NTC1,8K 150mm	NTC 1.8K	1101-7021-2031-000	43,42 €
TF65 NTC1,8K 200mm	NTC 1.8K	1101-7021-2041-000	43,96 €
TF65 NTC1,8K 250mm	NTC 1.8K	1101-7021-2051-000	46,16 €
TF65 NTC1,8K 300mm	NTC 1.8K	1101-7021-2061-000	47,74 €
TF65 NTC1,8K 350mm	NTC 1.8K	1101-7021-2071-000	48,60 €
TF65 NTC1,8K 400mm	NTC 1.8K	1101-7021-2081-000	49,72 €
TF65 NTC10K xx	NTC 10K	IP67	
TF65 NTC10K 50mm	NTC 10K	1101-7021-5011-000	40,05 €
TF65 NTC10K 100mm	NTC 10K	1101-7021-5021-000	41,73 €
TF65 NTC10K 150mm	NTC 10K	1101-7021-5031-000	43,42 €
TF65 NTC10K 200mm	NTC 10K	1101-7021-5041-000	43,96 €
TF65 NTC10K 250mm	NTC 10K	1101-7021-5051-000	46,16 €
TF65 NTC10K 300mm	NTC 10K	1101-7021-5061-000	47,74 €
TF65 NTC10K 350mm	NTC 10K	1101-7021-5071-000	48,60 €
TF65 NTC10K 400mm	NTC 10K	1101-7021-5081-000	49,72 €
TF65 NTC20K xx	NTC 20K	IP67	
TF65 NTC20K 50mm	NTC 20K	1101-7021-6011-000	40,05 €
TF65 NTC20K 100mm	NTC 20K	1101-7021-6021-000	41,73 €
TF65 NTC20K 150mm	NTC 20K	1101-7021-6031-000	43,42 €
TF65 NTC20K 200mm	NTC 20K	1101-7021-6041-000	43,96 €
TF65 NTC20K 250mm	NTC 20K	1101-7021-6051-000	46,04 €
TF65 NTC20K 300mm	NTC 20K	1101-7021-6061-000	47,74 €
TF65 NTC20K 350mm	NTC 20K	1101-7021-6071-000	48,60 €
TF65 NTC20K 400mm	NTC 20K	1101-7021-6081-000	49,72 €
Note:	Other sensors optional	on request	
Optional:	Cable connection with M12 connector according to DIN EN 61076-2-101	on request	



Immersion / screw-in / duct temperature sensors
with passive output

THERMASGARD® TF 43 Temperature sensors (Basic device with snap-on lid), *Standard*

Type / WG03 / EL	Sensor / Output	Item No.	Price
TF43 PT100 xx	Pt100	IP 54	
TF43 Pt100 50mm	Pt100 (according to DIN EN 60 751, class B)	1101-7010-1013-000	31,19 €
TF43 Pt100 100mm	Pt100 (according to DIN EN 60 751, class B)	1101-7010-1023-000	31,32 €
TF43 Pt100 150mm	Pt100 (according to DIN EN 60 751, class B)	1101-7010-1033-000	32,33 €
TF43 Pt100 200mm	Pt100 (according to DIN EN 60 751, class B)	1101-7010-1043-000	33,22 €
TF43 Pt100 250mm	Pt100 (according to DIN EN 60 751, class B)	1101-7010-1053-000	34,92 €
TF43 Pt100 300mm	Pt100 (according to DIN EN 60 751, class B)	1101-7010-1063-000	37,79 €
TF43 Pt100 350mm	Pt100 (according to DIN EN 60 751, class B)	1101-7010-1073-000	38,94 €
TF43 Pt100 400mm	Pt100 (according to DIN EN 60 751, class B)	1101-7010-1083-000	40,18 €
TF43 PT1000 xx	Pt1000	IP 54	
TF43 Pt1000 50mm	Pt1000 (according to DIN EN 60 751, class B)	1101-7010-5011-000	31,19 €
TF43 Pt1000 100mm	Pt1000 (according to DIN EN 60 751, class B)	1101-7010-5021-000	31,32 €
TF43 Pt1000 150mm	Pt1000 (according to DIN EN 60 751, class B)	1101-7010-5031-000	32,33 €
TF43 Pt1000 200mm	Pt1000 (according to DIN EN 60 751, class B)	1101-7010-5041-000	33,22 €
TF43 Pt1000 250mm	Pt1000 (according to DIN EN 60 751, class B)	1101-7010-5051-000	34,92 €
TF43 Pt1000 300mm	Pt1000 (according to DIN EN 60 751, class B)	1101-7010-5061-000	37,79 €
TF43 Pt1000 350mm	Pt1000 (according to DIN EN 60 751, class B)	1101-7010-5071-000	38,94 €
TF43 Pt1000 400mm	Pt1000 (according to DIN EN 60 751, class B)	1101-7010-5081-000	40,18 €
TF43 PT1000A xx	Pt1000A	IP 54	
TF43 Pt1000A 50mm	Pt1000 (according to VDI/VDE 3512, class A-TGA)	1101-7010-6013-000	33,15 €
TF43 Pt1000A 100mm	Pt1000 (according to VDI/VDE 3512, class A-TGA)	1101-7010-6023-000	33,30 €
TF43 Pt1000A 150mm	Pt1000 (according to VDI/VDE 3512, class A-TGA)	1101-7010-6033-000	34,28 €
TF43 Pt1000A 200mm	Pt1000 (according to VDI/VDE 3512, class A-TGA)	1101-7010-6043-000	35,18 €
TF43 Pt1000A 250mm	Pt1000 (according to VDI/VDE 3512, class A-TGA)	1101-7010-6053-000	36,87 €
TF43 Pt1000A 300mm	Pt1000 (according to VDI/VDE 3512, class A-TGA)	1101-7010-6063-000	39,75 €
TF43 Pt1000A 350mm	Pt1000 (according to VDI/VDE 3512, class A-TGA)	1101-7010-6073-000	40,92 €
TF43 Pt1000A 400mm	Pt1000 (according to VDI/VDE 3512, class A-TGA)	1101-7010-6083-000	42,16 €
TF43 Ni1000 xx	Ni 1000	IP 54	
TF43 Ni1000 50mm	Ni1000 (according to DIN EN 43 760, class B, TCR = 6180 ppm / K)	1101-7010-9011-000	31,96 €
TF43 Ni1000 100mm	Ni1000 (according to DIN EN 43 760, class B, TCR = 6180 ppm / K)	1101-7010-9021-000	34,99 €
TF43 Ni1000 150mm	Ni1000 (according to DIN EN 43 760, class B, TCR = 6180 ppm / K)	1101-7010-9031-000	35,25 €
TF43 Ni1000 200mm	Ni1000 (according to DIN EN 43 760, class B, TCR = 6180 ppm / K)	1101-7010-9041-000	36,01 €
TF43 Ni1000 250mm	Ni1000 (according to DIN EN 43 760, class B, TCR = 6180 ppm / K)	1101-7010-9051-000	37,03 €
TF43 Ni1000 300mm	Ni1000 (according to DIN EN 43 760, class B, TCR = 6180 ppm / K)	1101-7010-9061-000	39,46 €
TF43 Ni1000 350mm	Ni1000 (according to DIN EN 43 760, class B, TCR = 6180 ppm / K)	1101-7010-9071-000	40,59 €
TF43 Ni1000 400mm	Ni1000 (according to DIN EN 43 760, class B, TCR = 6180 ppm / K)	1101-7010-9081-000	42,41 €
TF43 NI1000TK xx	Ni1000 TK5000	IP 54	
TF43 NiTK 50mm	Ni1000 TK5000 (TCR = 5000 ppm / K), LG-Ni1000	1101-7011-0011-000	32,02 €
TF43 NiTK 100mm	Ni1000 TK5000 (TCR = 5000 ppm / K), LG-Ni1000	1101-7011-0021-000	35,05 €
TF43 NiTK 150mm	Ni1000 TK5000 (TCR = 5000 ppm / K), LG-Ni1000	1101-7011-0031-000	35,41 €
TF43 NiTK 200mm	Ni1000 TK5000 (TCR = 5000 ppm / K), LG-Ni1000	1101-7011-0041-000	36,16 €
TF43 NiTK 250mm	Ni1000 TK5000 (TCR = 5000 ppm / K), LG-Ni1000	1101-7011-0051-000	37,15 €
TF43 NiTK 300mm	Ni1000 TK5000 (TCR = 5000 ppm / K), LG-Ni1000	1101-7011-0061-000	39,62 €
TF43 NiTK 350mm	Ni1000 TK5000 (TCR = 5000 ppm / K), LG-Ni1000	1101-7011-0071-000	40,86 €
TF43 NiTK 400mm	Ni1000 TK5000 (TCR = 5000 ppm / K), LG-Ni1000	1101-7011-0081-000	42,57 €

Continued on next page...

High-performance encapsulation against
vibration, mechanical stress and humidity



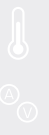

THERMASGARD® TF 43 Temperature sensors (Basic device with snap-on lid), <i>Standard</i>			
Type/WG03/EL	Sensor/Output	Item No.	Price
TF43 LM235Z xx	LM235Z	IP54	
TF43 LM235Z 50mm	LM235Z (TCR = 10 mV / K; 2.73 V at 0 °C), KP10	1101-7012-1011-000	32,60 €
TF43 LM235Z 100mm	LM235Z (TCR = 10 mV / K; 2.73 V at 0 °C), KP10	1101-7012-1021-000	32,95 €
TF43 LM235Z 150mm	LM235Z (TCR = 10 mV / K; 2.73 V at 0 °C), KP10	1101-7012-1031-000	34,13 €
TF43 LM235Z 200mm	LM235Z (TCR = 10 mV / K; 2.73 V at 0 °C), KP10	1101-7012-1041-000	34,92 €
TF43 LM235Z 250mm	LM235Z (TCR = 10 mV / K; 2.73 V at 0 °C), KP10	1101-7012-1051-000	35,32 €
TF43 LM235Z 300mm	LM235Z (TCR = 10 mV / K; 2.73 V at 0 °C), KP10	1101-7012-1061-000	38,35 €
TF43 LM235Z 350mm	LM235Z (TCR = 10 mV / K; 2.73 V at 0 °C), KP10	1101-7012-1071-000	38,82 €
TF43 LM235Z 400mm	LM235Z (TCR = 10 mV / K; 2.73 V at 0 °C), KP10	1101-7012-1081-000	41,24 €
TF43 NTC 1.8K xx	NTC 1.8K	IP54	
TF43 NTC1,8K 50mm	NTC 1.8K	1101-7011-2011-000	31,19 €
TF43 NTC1,8K 100mm	NTC 1.8K	1101-7011-2021-000	32,88 €
TF43 NTC1,8K 150mm	NTC 1.8K	1101-7011-2031-000	33,72 €
TF43 NTC1,8K 200mm	NTC 1.8K	1101-7011-2041-000	34,51 €
TF43 NTC1,8K 250mm	NTC 1.8K	1101-7011-2051-000	36,16 €
TF43 NTC1,8K 300mm	NTC 1.8K	1101-7011-2061-000	37,37 €
TF43 NTC1,8K 350mm	NTC 1.8K	1101-7011-2071-000	38,63 €
TF43 NTC1,8K 400mm	NTC 1.8K	1101-7011-2081-000	39,62 €
TF43 NTC10K xx	NTC 10K	IP54	
TF43 NTC10K 50mm	NTC 10K	1101-7011-5011-000	31,19 €
TF43 NTC10K 100mm	NTC 10K	1101-7011-5021-000	32,88 €
TF43 NTC10K 150mm	NTC 10K	1101-7011-5031-000	33,72 €
TF43 NTC10K 200mm	NTC 10K	1101-7011-5041-000	34,51 €
TF43 NTC10K 250mm	NTC 10K	1101-7011-5051-000	36,16 €
TF43 NTC10K 300mm	NTC 10K	1101-7011-5061-000	37,37 €
TF43 NTC10K 350mm	NTC 10K	1101-7011-5071-000	38,63 €
TF43 NTC10K 400mm	NTC 10K	1101-7011-5081-000	39,62 €
TF43 NTC20K xx	NTC 20K	IP54	
TF43 NTC20K 50mm	NTC 20K	1101-7011-6011-000	31,19 €
TF43 NTC20K 100mm	NTC 20K	1101-7011-6021-000	32,88 €
TF43 NTC20K 150mm	NTC 20K	1101-7011-6031-000	33,72 €
TF43 NTC20K 200mm	NTC 20K	1101-7011-6041-000	34,51 €
TF43 NTC20K 250mm	NTC 20K	1101-7011-6051-000	36,16 €
TF43 NTC20K 300mm	NTC 20K	1101-7011-6061-000	37,37 €
TF43 NTC20K 350mm	NTC 20K	1101-7011-6071-000	38,63 €
TF43 NTC20K 400mm	NTC 20K	1101-7011-6081-000	39,62 €
Note	Other sensors optional	on request	
Optional:	Cable connection with M12 connector according to DIN EN 61076-2-101	on request	



Immersion / screw-in / duct temperature sensors
 with passive output

One basic device in four variants...



PATENTED
 DE 10 2012 017 500.0

**TFxx +
 TH08-MS-G/xx**

Immersion / screw-in
 temperature sensor
 with immersion sleeve,
 polished brass

**TFxx +
 TH08-VA/xx**

Immersion / screw-in
 temperature sensor
 with immersion sleeve,
 stainless steel, V4A

**TFxx +
 TH08-VA/xx/90**

Immersion / screw-in
 temperature sensor with
 immersion sleeve with
 neck tube, stainless steel, V4A

**TFxx +
 MF-15-K**

Duct temperature sensor
 with mounting flange, plastic
 sleeve with neck
 tube, stainless steel, V4A

TH08-MS-G/xx
 Dimensional drawing
 [mm]

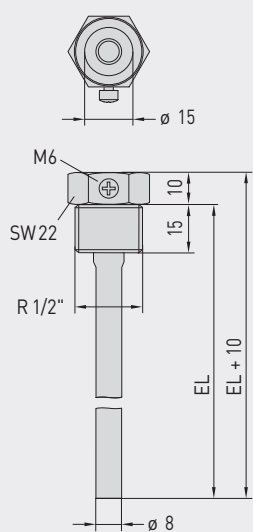

TH08-VA/xx
 Dimensional drawing
 [mm]

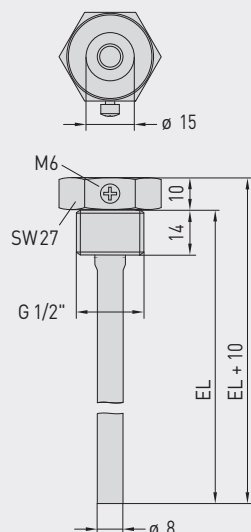

TH08-VA/xx/90
 Dimensional drawing
 [mm]

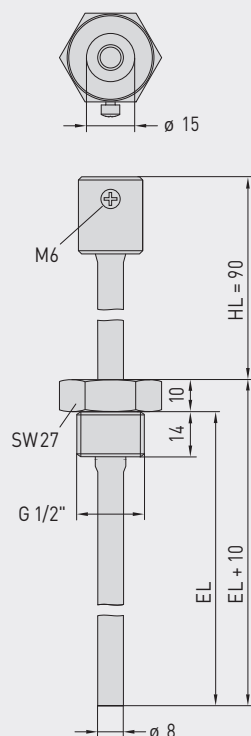

MF-15-K
 Dimensional drawing
 [mm]

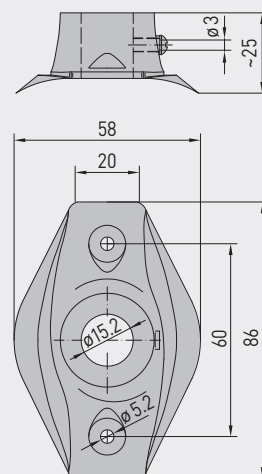



...through combination with accessories:



TH08-MS-G/xx
Immersion sleeve,
polished brass,
thread-sealing, conical,
according to DIN 10226



TH08-VA/xx
Immersion sleeve,
stainless steel, V4A,
flat-sealing, cylindrical,
according to DIN 228



TH08-VA/xx/90
Immersion sleeve with neck tube,
stainless steel, V4A,
flat-sealing, cylindrical,
according to DIN 228



MF-15-K
Mounting flange,
plastic

THERMASGARD® TH08 Immersion sleeve Ø 8 mm (Accessories)					
Type / WG01B	p _{max} (static)	T _{max}	Inserted Length (EL)	Item No.	Price
TH08-MS-G xx	polished brass			without neck tube	
TH08-MS-G 50MM	10 bar	+150 °C	50 mm	7100-0017-0010-132	13,82 €
TH08-MS-G 100MM	10 bar	+150 °C	100 mm	7100-0017-0020-132	14,46 €
TH08-MS-G 150MM	10 bar	+150 °C	150 mm	7100-0017-0030-132	15,64 €
TH08-MS-G 200MM	10 bar	+150 °C	200 mm	7100-0017-0040-132	16,73 €
TH08-MS-G 250MM	10 bar	+150 °C	250 mm	7100-0017-0050-132	19,37 €
TH08-MS-G 300MM	10 bar	+150 °C	300 mm	7100-0017-0060-132	20,25 €
TH08-MS-G 350MM	10 bar	+150 °C	350 mm	7100-0017-0070-132	20,79 €
TH08-MS-G 400MM	10 bar	+150 °C	400 mm	7100-0017-0080-132	21,32 €
TH08-VA/xx	Stainless steel, V4A (1.4571)			without neck tube	
TH08-VA 50MM	40 bar	+600 °C	50 mm	7100-0012-0010-132	23,82 €
TH08-VA 100MM	40 bar	+600 °C	100 mm	7100-0012-0020-132	26,24 €
TH08-VA 150MM	40 bar	+600 °C	150 mm	7100-0012-0030-132	28,39 €
TH08-VA 200MM	40 bar	+600 °C	200 mm	7100-0012-0040-132	29,78 €
TH08-VA 250MM	40 bar	+600 °C	250 mm	7100-0012-0050-132	37,06 €
TH08-VA 300MM	40 bar	+600 °C	300 mm	7100-0012-0060-132	38,78 €
TH08-VA 350MM	40 bar	+600 °C	350 mm	7100-0012-0070-132	39,53 €
TH08-VA 400MM	40 bar	+600 °C	400 mm	7100-0012-0080-132	40,60 €
TH08-VA/xx/90	Stainless steel, V4A (1.4571)			with neck tube (90 mm)	
TH08-VA 50/90MM	40 bar	+600 °C	50 mm	7100-0012-0012-132	32,04 €
TH08-VA 100/90MM	40 bar	+600 °C	100 mm	7100-0012-0022-132	33,49 €
TH08-VA 150/90MM	40 bar	+600 °C	150 mm	7100-0012-0032-132	35,13 €
TH08-VA 200/90MM	40 bar	+600 °C	200 mm	7100-0012-0042-132	36,63 €
TH08-VA 250/90MM	40 bar	+600 °C	250 mm	7100-0012-0052-132	38,38 €
TH08-VA 300/90MM	40 bar	+600 °C	300 mm	7100-0012-0062-132	41,60 €
Note:	inner diameter of socket 15.0 mm For further information see last chapter!				
Mounting flange (Accessories)					
Type / WG01B		T _{max}		Item No.	Price
MF					
MF-15-K	Mounting flange, plastic, 56.8x84.3 mm, Ø 15.2 mm tube gland	+100 °C		7100-0032-0000-000	6,75 €
Note:	For further information see last chapter!				