

Mean value temperature measuring transducer, incl. mounting flange, Bluetooth-enabled, with EtherCATP port

Networkable mean value temperature measuring transducer **THERMASGARD® MWTM-EtherCATP** with M8 plug-in connector (EtherCATP-encoded), Bluetooth-enabled, in an impact-resistant plastic housing with quick-locking screws, optionally with /without display and bar graph, with bendable sensor rod (0.4...20m, fully active) in a robust plastic-coated protective copper tube, incl. mounting flange.

The rod sensor is used to detect the mean temperature (mean value) in gaseous media. It is used in ventilation and air conditioning ducts over the entire cross-section or on a defined length (laid along a meandering route, it uniformly detects the surrounding temperature). For proper mounting of the rod, mounting clamps **MK-05-M** (accessory) are available. The sensor is factory-calibrated.

EtherCATP-enabled measuring transducer for industrial requirements with maximum reliability: includes easy PLC integration using the device's ESI configuration file, diagnostics (such as communication failure counter), advanced settings options, access to historical data (min / max) and establishing the sensor's service interval. Optionally with large illuminated display (3-line, customised programming in the 7-segment and dot-matrix range) and bar graph (7-digit, LEDs freely configurable) for graphical display, e.g., as a traffic light indicator.

MWTM-EtherCATP
Rod length
0,4 m



EtherCATP
Cable connection and
LED status display

TECHNICAL DATA

Power supply:	24 V DC via EtherCATP (U _S)
Power consumption:	< 3 W
Bus protocol:	EtherCAT
Radio technology:	Bluetooth (LE)
Sensor:	Pt1000, DIN EN 60751, class B
Measuring range:	-50...+150 °C T_{min} -50 °C, T_{max} +80 °C
Accuracy in temperature:	Typically ±0.2 K at +25 °C
Medium:	Clean air and non-aggressive, non-combustible gases
Sensors:	active across the entire length (averaging)
Rod material:	protective tube made from copper, plastic-coated, with anti-kink spring and sleeve, stainless steel V4A (1.4571)
Rod dimensions:	Ø = 5.0 mm, nominal length (NL) = 0.4 m / 3 m / 6 m (nominal length optionally up to max. 20 m)
Rod laying:	Bending radius: > 35 mm Vibration load: ≤ 0.5 g Tensile load: < 480 N
Housing:	Plastic, UV-resistant, polyamide material, 30% glass-globe reinforced, with quick-locking screws (slotted / Phillips head combination), colour traffic white (similar to RAL 9016), housing cover for display is transparent!
Housing dimension:	126 x 90 x 50mm (Tyr 2)
Cable connection:	M8 plug-in connector , EtherCATP-encoded
Process connection:	Using plastic mounting flange (included in the delivery scope) and mounting clamps MK-05-M (optional accessory)
Ambient temperature:	Measuring transducer -30...+70 °C
Permitted humidity:	< 95% RH, non-precipitating air
Protection class:	III (according to EN 60 730)
Protection type:	IP 54 (according to EN 60 529) when built-in
Standards:	CE conformity, according to EMC Directive 2014 / 30 / EU, according to RED 2014 / 53 / EU
Equipment:	Display with illumination , 3-line, customised programming, cutout approx. W51 x H29mm, to display the actual temperature or a customised display value. Bar graph , 7-digit, LEDs freely configurable, to graphically display the reading.

ACCESSORIES See table

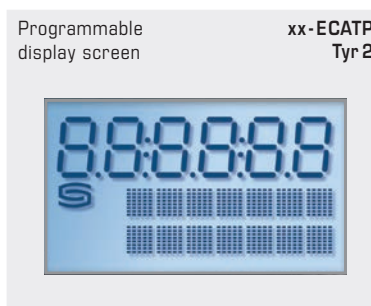
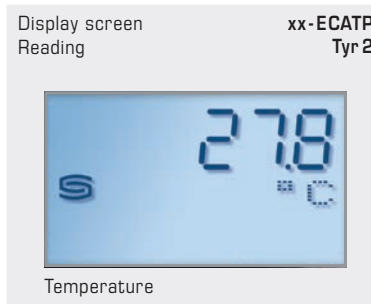



S+S REGELTECHNIK

Mean value temperature measuring transducer, incl. mounting flange, Bluetooth-enabled, with EtherCAT port

Dimensional drawing

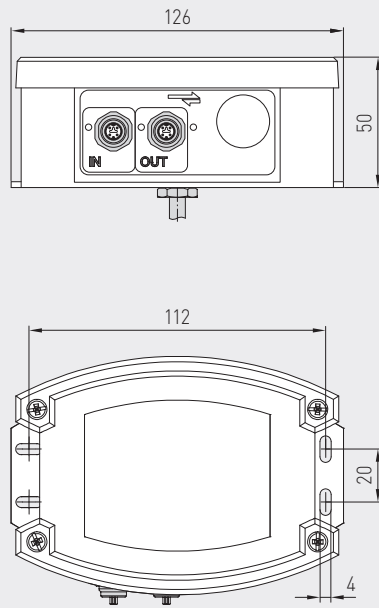

MWTM - EtherCATP

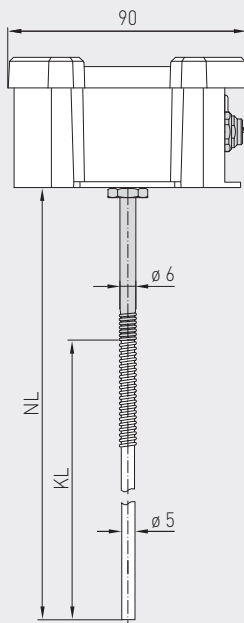

M8-plug-in connector
EtherCATP-encoded

MWTM - EtherCATP

Rod length
3 m / 6 m



Dimensional drawing

KRD-04

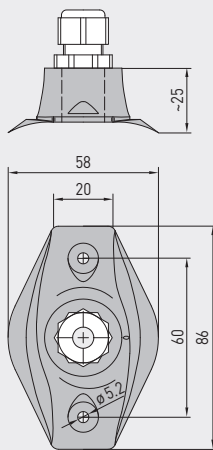

Dimensional drawing

MF-06-K

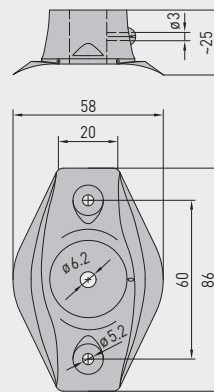

MF-06-K
Mounting flange,
plastic
(included in the
scope of delivery)



KRD-04
Capillary tube
gland bracket,
plastic
(optional)



Dimensional drawing

MK-05-M

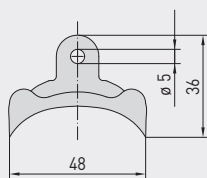

Dimensional drawing

MF-06-M

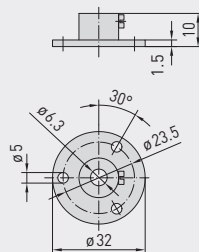

MF-06-M
Mounting flange,
metal
(optional)



MK-05-M
Galvanised steel
mounting clamps
(optional)



Mean value temperature measuring transducer,
incl. mounting flange, Bluetooth-enabled,
with EtherCAT P port

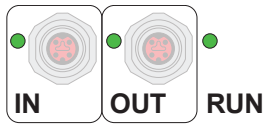

MWTM-EtherCAT P
with display and bar graph

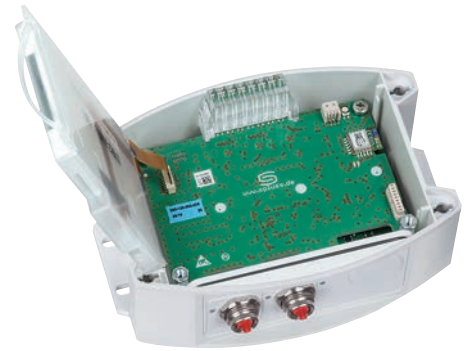

EtherCAT P	LED status display
1. LED	"IN"
off	no connection to upstream EtherCAT module
illuminated	LINK: connection to upstream EtherCAT module
blinking	ACT: communication with upstream EtherCAT module
2. LED	"OUT"
off	no connection to downstream EtherCAT module
illuminated	LINK: connection to downstream EtherCAT module
blinking	ACT: communication with downstream EtherCAT module
3. LED	"RUN"
off	EtherCAT module is in "Init" state
quickly blinking	EtherCAT module is in "Pre-Operational" state
slowly blinking	EtherCAT module is in "Safe-Operational" state
illuminated	EtherCAT module is in "Operational" state
The status LEDs are next to the cable connection.	



S+S REGELTECHNIK

THERMASGARD® MWTM - EtherCAT P

Mean value temperature measuring transducer,
incl. mounting flange, Bluetooth-enabled,
with EtherCAT port

MWTM - EtherCAT P

Rod length
3 m / 6 m

MWTM - EtherCAT P

Rod length
0,4 m



THERMASGARD® MWTM - EtherCAT P Mean value temperature measuring transducer with EtherCAT port

Type / WG02	Measuring Range Temperature	Output	Rod length	Bar graph Display	Item No.	Price
MWTM-ECATP xx						
MWTM-ECATP 0,4m	-50...+150 °C	EtherCAT P	0,4 m		2001-4211-9100-001	424,50 €
MWTM-ECATP 0,4m LCD				<input type="checkbox"/> <input checked="" type="checkbox"/>	2001-4212-9100-001	475,55 €
MWTM-ECATP 3,0m	-50...+150 °C	EtherCAT P	3,0 m		2001-4211-9100-011	462,68 €
MWTM-ECATP 3,0m LCD				<input type="checkbox"/> <input checked="" type="checkbox"/>	2001-4212-9100-011	513,71 €
MWTM-ECATP 6,0m	-50...+150 °C	EtherCAT P	6,0 m		2001-4211-9100-021	510,38 €
MWTM-ECATP 6,0m LCD				<input type="checkbox"/> <input checked="" type="checkbox"/>	2001-4212-9100-021	561,40 €

Note: Cable connection with **M8 plug-in connector** (EtherCATP-encoded)

ACCESSORIES

MF-06-K	Mounting flange, plastic (included in the scope of delivery)	7100-0030-1000-000	6,75 €
MF-06-M	Mounting flange, metal, galvanised steel, Ø = 35 mm	7100-0030-5000-100	13,87 €
KRD-04	Capillary tube gland bracket, plastic	7100-0030-7000-000	9,84 €
MK-05-M	Galvanised steel mounting clamps (6 pieces)	7100-0034-0000-000	10,91 €

For further information, see last chapter Accessories!

