

Mean value / rod / duct temperature sensor including mounting flange, with passive output

Mean-value temperature sensor **THERMASGARD® MWTF** (rod sensor 0.4...20 m) with passive output, in an impact-resistant plastic housing with quick-locking screws, with bendable sensor rod (fully active), protective tube made from copper, plastic-coated, and anti-kink spring, incl. mounting flange.

Mean-value temperature sensor **THERMASGARD® MWTF-SD** (rod sensor 3 m / 6 m) with passive output, in an impact-resistant plastic housing with snap-on lid, with bendable sensor rod (fully active), protective tube made from reinforced thermoplastic hose and anti-kink spring, incl. mounting flange.

The sensor is used to detect the mean temperature (mean value) in gaseous media, e.g. in ventilation and air conditioning ducts over the entire cross section or over a defined length. Laid along a meandering route, it uniformly detects the surrounding temperature, as a duct temperature sensor. For proper mounting of the rod, mounting clamps **MK-05-M** (accessories) are available.

MWTF
 Rod length 0,4 m
 (IP 65)



TECHNICAL DATA

Measuring range:	-30...+80 °C
Sensors / output:	see table, passive
Connection type:	2-wire connection (4-wire connection on PT100, optional on other sensors)
Testing current:	< 0.6 mA (Pt1000) < 1.0 mA (Pt100) < 0.3 mA (Ni1000)
Sensor:	active over the entire length (averaging)
Rod material:	protective tube made from copper, plastic-coated, (MWTF) (made from reinforced thermoplastic hose on the MWTF-SD , with anti-kink spring and sleeve, stainless steel, V4A (1.4571))
Rod dimensions:	Ø = 5.0 mm, nominal length (NL) = 0.4 m / 3 m / 6 m, see table (nominal length optionally up to max. 20 m)
Rod laying:	Observe the admissible values! Bending radius: > 35 mm Vibration load: ≤ 0.5 g Tensile load: < 480 N for the MWTF < 100 N for the MWTF-SD
Housing:	plastic, UV-resistant, material polyamide, 30% glass-globe reinforced, with quick-locking screws (slotted / Phillips head combination), colour traffic white (similar to RAL 9016)
Housing dimensions:	72 x 64 x 37.8 mm (Tyr 1)
Cable connection:	cable gland , plastic (M 16 x 1.5; with strain relief, exchangeable, max. inner diameter 10.4 mm) or M12 connector according to DIN EN 61076-2-101 (optional on request)
Electrical connection:	0.14 - 1.5 mm² via terminal screws
Process connection:	by mounting flange, plastic, (galvanised steel optional, see accessories) and mounting clamps MK-05-M
Ambient temperature:	-20...+80 °C
Humidity:	< 95% RH, non-precipitating air
Protection class:	III (according to EN 60 730)
Protection type:	IP 54 (according to EN 60 529) for the MWTF-SD IP 65 (according to EN 60 529) for the MWTF Housing tested, TÜV SÜD, report no. 713139052 (Tyr 1)
ACCESSORIES	see table

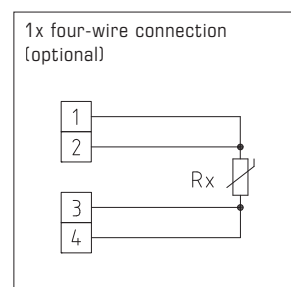
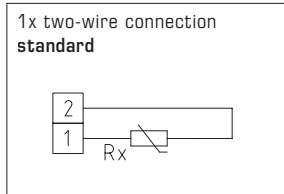



S+S REGELTECHNIK

Thermasgard® MWTF
Thermasgard® MWTF-SD

Mean value / rod / duct temperature sensor
including mounting flange, with passive output

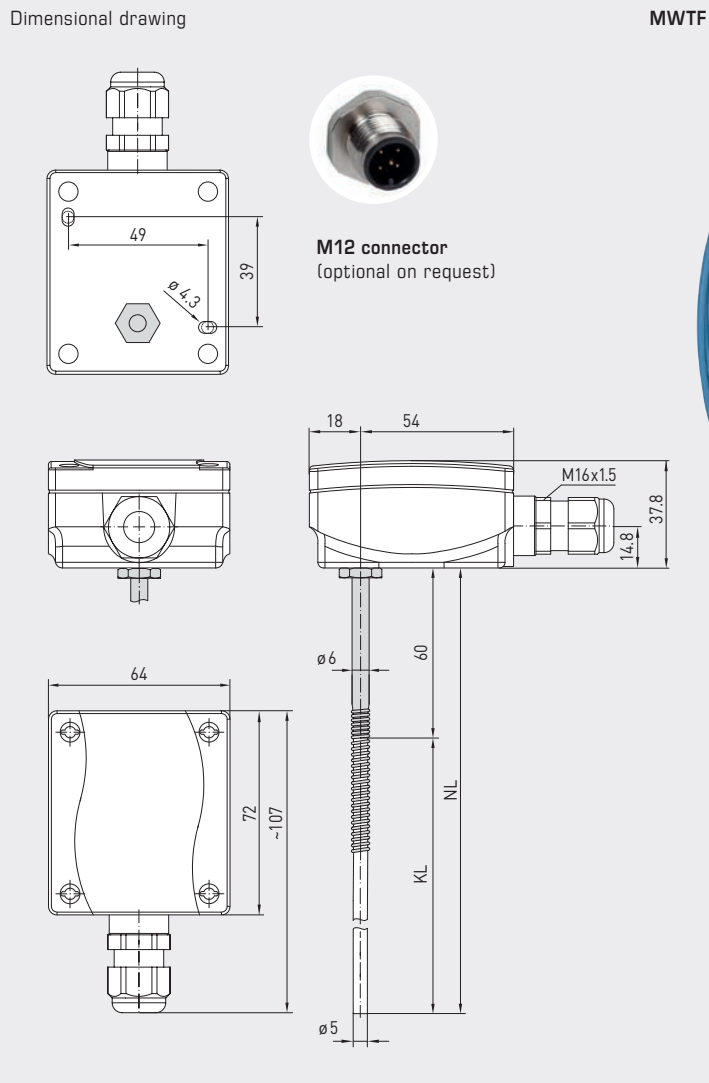

MWTF
Rod length 3 m / 6 m
(IP 65)



MWTF-SD
Rod length 3 m / 6 m
(IP 54)



Mean value / rod / duct temperature sensor
including mounting flange, with passive output

MWTF
Rod length 0,4 m
(IP 65)



Dimensional drawing **KRD-04**

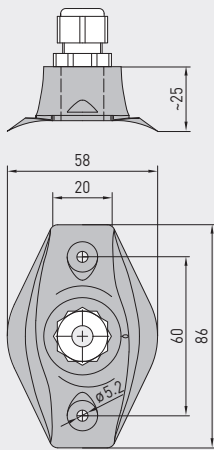

Dimensional drawing **MF-06-K**

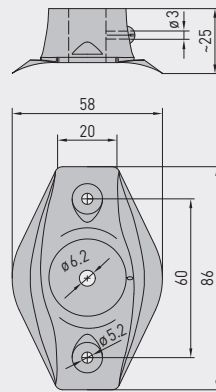

MF-06-K
Mounting flange,
plastic
(Included in the
scope of delivery)



KRD-04
Capillary tube
bushing, plastic
(optional)



Dimensional drawing **MK-05-M**

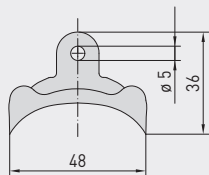

Dimensional drawing **MF-06-M**

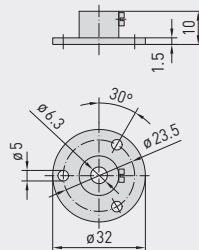

MF-06-M
Mounting flange,
metal
(optional)



MK-05-M
Mounting clamps,
galvanised steel
(from 3 m rod length,
included in the scope
of delivery)





S+S REGELTECHNIK

THERMASGARD® MWTF
THERMASGARD® MWTF-SD

Mean value / rod / duct temperature sensor
including mounting flange, with passive output

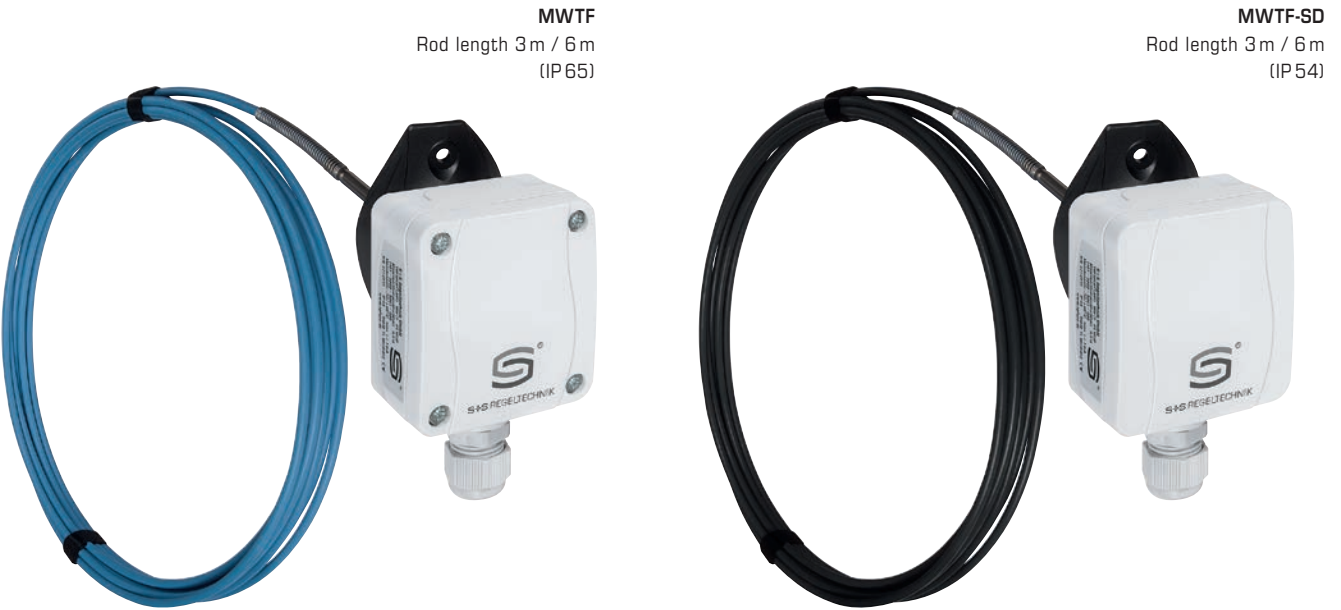

MWTF
Rod length 3 m / 6 m
(IP65)

MWTF-SD
Rod length 3 m / 6 m
(IP54)

THERMASGARD® MWTF-SD		Mean-value temperature sensor with rod made from reinforced thermoplastic hose, <i>Standard</i>		
Type / WG03B	Sensor / Output	Rod length	Item No.	Price
MWTF-SD	Pt1000		IP54	
MWTF-SD Pt1000 3m	Pt1000 (according to DIN EN 60 751, class B)	3.0 m	1101-3050-5231-200	104,41 €
MWTF-SD Pt1000 6m	Pt1000 (according to DIN EN 60 751, class B)	6.0 m	1101-3050-5261-200	116,16 €
Optional:	Cable connection with M12 connector according to DIN EN 61076-2-101		on request	

THERMASGARD® MWTF		Mean-value temperature sensor with rod made from copper, plastic-coated, <i>Premium</i>		
Type / WG03	Sensor / Output	Rod length	Item No.	Price
MWTF	Pt100		IP65	
MWTF Pt100 0,4m	Pt100 (according to DIN EN 60 751, class B)	0.4 m	1101-3050-1083-000	91,31 €
MWTF Pt100 3m	Pt100 (according to DIN EN 60 751, class B)	3.0 m	1101-3050-1233-000	160,11 €
MWTF Pt100 6m	Pt100 (according to DIN EN 60 751, class B)	6.0 m	1101-3050-1263-000	214,92 €
MWTF	Pt1000		IP65	
MWTF Pt1000 0,4m	Pt1000 (according to DIN EN 60 751, class B)	0.4 m	1101-3050-5081-000	109,43 €
MWTF Pt1000 3m	Pt1000 (according to DIN EN 60 751, class B)	3.0 m	1101-3050-5231-000	160,11 €
MWTF Pt1000 6m	Pt1000 (according to DIN EN 60 751, class B)	6.0 m	1101-3050-5261-000	240,01 €
MWTF	Ni1000		IP65	
MWTF Ni1000 0,4m	Ni1000 (according to DIN EN 43 760, class B)	0.4 m	1101-3050-9081-000	104,69 €
MWTF Ni1000 3m	Ni1000 (according to DIN EN 43 760, class B)	3.0 m	1101-3050-9231-000	167,85 €
MWTF Ni1000 6m	Ni1000 (according to DIN EN 43 760, class B)	6.0 m	1101-3050-9261-000	214,92 €
Extra charge:	Per meter sensor cable (from 6 m to max. 20 m)		on request	
Optional:	Cable connection with M12 connector according to DIN EN 61076-2-101		on request	

ACCESSORIES			
MF-06-K	Mounting flange, plastic (included in the scope of delivery)	7100-0030-1000-000	6,75 €
MF-06-M	Mounting flange, metal, galvanised steel, Ø = 35 mm	7100-0030-5000-100	13,87 €
KRD-04	Capillary tube gland bracket, plastic	7100-0030-7000-000	9,84 €
MK-05-M	Mounting clamps, galvanised steel (6 pieces) (from 3 m rod length, included in the scope of delivery)	7100-0034-0000-000	10,91 €

For further information see last chapter!