

**Room motion sensor or presence detector,
in-wall in the panel switch programme,
with switching output**

Maintenance-free motion sensor/presence detector **KINASREG® FSBWF-W** with switching output, in in-wall housing, to detect the presence of people and movements (360° / approx. 10 m). The in-wall sensor is mounted in high-quality panel switch programmes, ideally of the brands Gira, Berker, Merten, Jung, Siemens or Busch-Jaeger (using in-wall adapters) either individually or in combination with light switches, socket outlets, etc.

The sensor is used for monitoring and detecting statuses and for motion-dependent control of room functions, e.g. for lowering the temperature of unused rooms. It is used indoors in corridors, offices, residential and business premises as well as industrial and storage halls.

The **infrared motion sensor** detects movement over an aperture angle of 90°/ 110° and a perimeter of 360°. The patented lens system with 20 individual lenses results in very small dark areas that are only a few centimetres wide even at a distance of 10 m, thereby reliably detecting small movements.

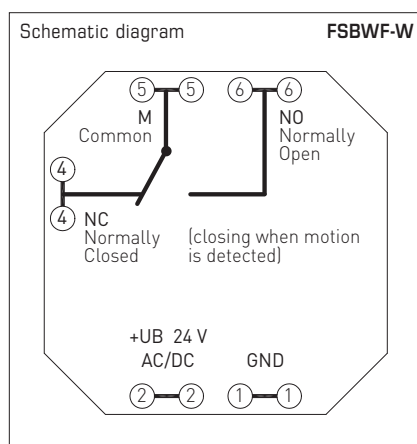
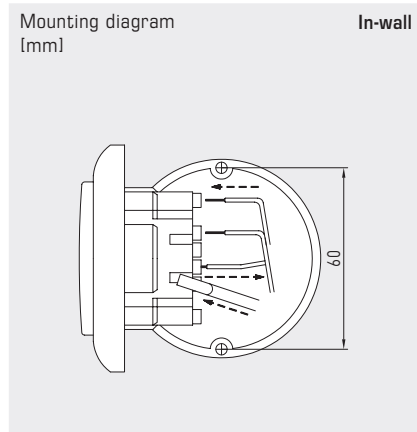

TECHNICAL DATA

Power supply:	24 V AC / DC (± 10 %),
Power consumption:	typically < 2.0 VA / 24 V AC; typically < 1.0 W / 24 V DC

MOTION

Sensor:	infra-red motion sensor
Detection range:	360° perimeter, aperture angle 90° / 110°, range approx. 10 m, circular
Motion detection:	of people and objects, necessary temperature difference between subject and surroundings ≥ 5 K
Output:	without / with motion + presence, potential-free changeover contact (24 V), 1 A resistive load

After-running time:	adjustable from approx. 4 seconds to approx. 16 minutes
Mounting:	in-wall flush box Ø 55 mm
Electrical connection:	max. 1.5 mm², via push-in terminals
Ambient temperature:	Storage -20...+50 °C; Operation 0...+50 °C
Permitted humidity:	max. 95 % RH, non-condensing air
Protection class:	III (according to EN 60 730)
Protection type:	IP 20 (according to EN 60 529)
Standards:	CE-conformity according to EMC Directive 2014 / 30 / EU

SWITCH PROGRAMME

Manufacturer:	GIRA System 55 (other switch programmes, manufacturers, colours as well as prices available upon request)
Housing:	plastic, the standard colour is pure glossy white (similar to RAL 9010) (other colours are available upon request with colour variants depending on the respective light switch programme)



S+S REGELTECHNIK

KINASREG® FSBWF-W

Room motion sensor or presence detector,
in-wall in the panel switch programme,
with switching output

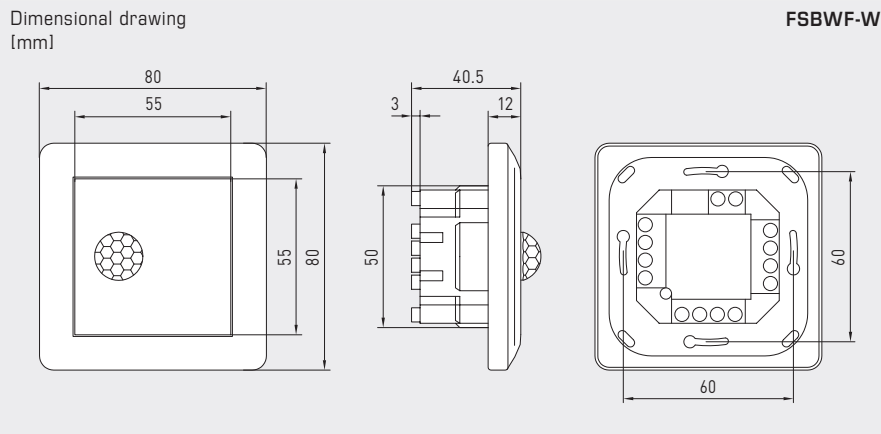

FSBWF-W



KINASREG® FSBWF-W		Room motion sensor or presence detector, in-wall		
Type / WG02	Detection of presence / motion	Output presence / motion	Item No.	Price
FSBWF-W				
FSBWF-W	Yes / No	Changeover contact	1401-5120-3000-162	271,09 €