

**In-ceiling temperature sensors
with passive output**

THERMASGARD® DTF is a small in-ceiling resistance thermometer with passive output for in-wall installation, e.g. in plasterboard walls or suspended ceilings. The in-ceiling temperature sensor DTF is preferably installed in ceilings and walls, blends in seamlessly with the overall architectural design and detects the temperature at the surface. The connecting head is pluggable for quick, easy mounting.

TECHNICAL DATA	
Measuring range:	-20...+90 °C
Sensors / output:	see table, passive
Connection type:	4-wire connection terminal 1 / 2: + (marked red, wire colours: yellow, brown) terminal 3 / 4: - (marked black, wire colours: white, green)
Testing current:	< 0.6 mA (Pt1000) < 1.0 mA (Pt100) < 0.3 mA (Ni1000, Ni1000 TK5000) < 2.0 mW (NTC xx) 400 µA...5 mA (LM235Z)
Connecting head:	plastic, material polycarbonate (PC), colour white (can be painted as an option), pluggable
Connecting cable:	PVC, LiYY, 4 x 0.14 mm ² , KL = approx. 2 m
Process connection:	inside suspended ceiling, ceiling cutout Ø = 30 mm, cover Ø = < 35 mm
Insulating resistance:	≥ 100 MΩ, at +20 °C (500V DC)
Humidity:	< 95 % RH, non-precipitating air
Protection class:	III (according to EN 60 730)
Protection type:	IP 30 (according EN 60529) Sensor in the built-in state

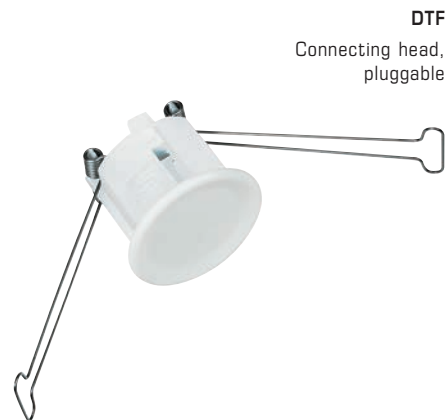

DTF
Connecting head,
pluggable

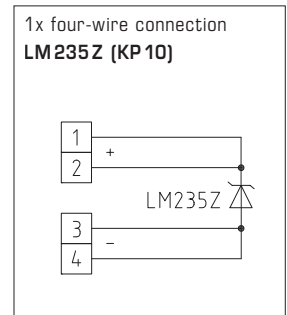
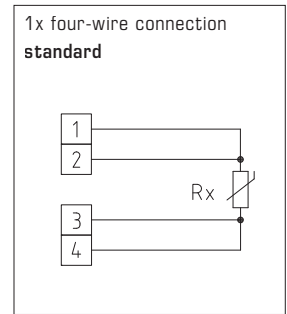
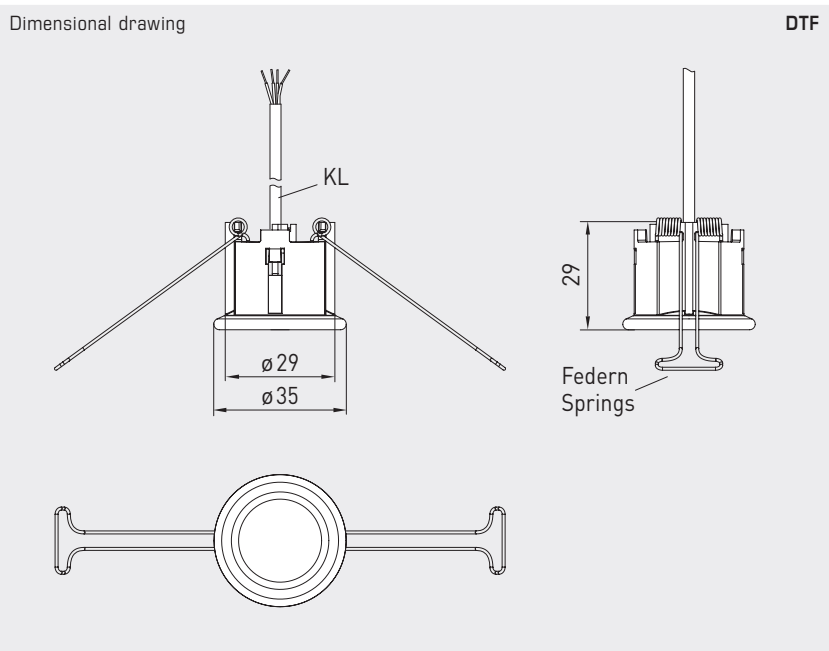



DTF



THERMASGARD® DTF		In-ceiling temperature sensors	
Type / WG03	Sensor / Output	Item No.	Price
DTF		IP30	
DTF Pt100	Pt100 (according to DIN EN 60 751, class B)	1101-60C0-1003-000	44,95 €
DTF Pt1000	Pt1000 (according to DIN EN 60 751, class B)	1101-60C0-5003-000	44,95 €
DTF Ni1000	Ni1000 (according to DIN EN 43760, class B, TCR = 6180 ppm / K)	1101-60C0-9003-000	44,66 €
DTF NiTK	Ni1000 TK5000 (TCR = 5000 ppm / K), LG- Ni1000	1101-60C1-0003-000	49,04 €
DTF LM235Z	LM235Z (TCR = 10 mV / K; 2.73 V at 0 °C), KP10	1101-60C2-1003-000	46,00 €
DTF NTC1,8K	NTC 1.8K	1101-60C1-2003-000	46,00 €
DTF NTC10K	NTC 10K	1101-60C1-5003-000	46,00 €
DTF NTC20K	NTC 20K	1101-60C1-6003-000	46,00 €
Note:	Other sensors optional	on request	